

**FLUKE®**

**Model 77 Series IV**  
Digital Multimeter

Users Manual

PN 2695884  
September 2006  
© 2006 Fluke Corporation. All rights reserved. Printed in USA  
All product names are trademarks of their respective companies.

## **Table of Contents**















<b>Title</b>	<b>Page</b>
Contacting Fluke .....	1
Warning and Caution Statements.....	1
Unsafe Voltage .....	1
Test Lead Alert .....	1
Battery Saver (Sleep Mode) .....	2
Terminals .....	2
Rotary Switch Positions .....	2
Display .....	3
MIN MAX AVG Recording Mode .....	4
AutoHOLD Modes.....	4
YELLOW Button .....	4
Display Backlight .....	4
Manual Ranging and Autoranging .....	5
Power-Up Options .....	5
Making Basic Measurements .....	6
Measuring AC and DC Voltage .....	6
Measuring Resistance .....	6
Measuring Capacitance.....	6
Testing for Continuity.....	7
Testing Diodes.....	7
Measuring AC or DC Current .....	8
Measuring Frequency.....	8
Using the Bar Graph.....	9
Cleaning.....	9
Testing the Fuses .....	9
Replacing the Battery and Fuses .....	10
Specifications.....	11

**⚠⚠ Warning. Read before using the Meter**

To avoid possible electrical shock or personal injury, follow these guidelines:

- ⇒ Use the Meter only as specified in this manual or the protection provided by the Meter might be impaired.
- ⇒ Do not use the Meter or test leads if they appear damaged, or if the Meter is not operating properly. If in doubt, have the Meter serviced.
- ⇒ Always use the proper terminals, switch position, and range for measurements.
- ⇒ Verify the Meter's operation by measuring a known voltage.
- ⇒ Do not apply more than the rated voltage, as marked on the Meter, between the terminals or between any terminal and earth ground.
- ⇒ Use caution with voltages above 30 V ac rms, 42 V ac peak, or 60 V dc. These voltages pose a shock hazard.
- ⇒ Disconnect circuit power and discharge all high-voltage capacitors before testing resistance, continuity, diodes, or capacitance.
- ⇒ Do not use the Meter around explosive gas or vapor.
- ⇒ When using the test leads, keep your fingers behind the finger guards.
- ⇒ Remove test leads from the Meter before opening the Meter case or battery door.

**Symbols**

	AC (Alternating Current)		Fuse
	DC (Direct Current)		Conforms to European Union directives
	DC/AC		Canadian Standards Association
	Earth ground		Double insulated
	Important Information; see manual		Hazardous Voltage
	Battery (Low battery when shown on display)		Underwriters Laboratories, Inc. Meter in accordance with IEC 61010-1. 54CJ
	Inspected and licensed by TÜV (Technischer Überwachungs Verein) Product Services		Conforms to relevant Australian standards
	VDE (Verband Deutscher Electroniker)		

## **Model 77 Series IV**

### **Digital Multimeter**

The Fluke **Model 77 Series IV** is a battery-powered, average responding-rms indicating multimeter (hereafter "the Meter"), with a 6000-count, 3 3/4-digit display, and a bar graph.

This meter meets CAT III and CAT IV IEC 61010 standards. The IEC 61010 safety standard defines four measurement categories (CAT I to IV) based on the magnitude of danger from transient impulses. CAT III meters are designed to protect against transients in fixed-equipment installations at the distribution level; CAT IV meters are designed to protect against transients from the primary supply level (overhead or underground utility service).

The Meter measures or tests the following:

- ◆ AC / DC voltage & current
- ◆ Resistance
- ◆ Voltage frequency
- ◆ Diodes
- ◆ Continuity
- ◆ Capacitance

#### **Warning and Caution Statements**

A **⚠⚠ Warning** identifies hazardous conditions and actions that could cause bodily harm or death.

A **Caution** identifies conditions and actions that could damage the Meter, the equipment under test, or cause permanent loss of data.

#### **Unsafe Voltage**

To alert you to the presence of a potentially hazardous voltage, when the Meter detects a voltage  $\geq 30$  V or a voltage overload (**OL**), the **⚡** symbol is displayed.

#### **Test Lead Alert**

To remind you to check that the test leads are in the correct terminals, **LED** is momentarily displayed when you move the rotary switch *to* or *from* the **mA** or **A** position.

#### **⚠ Warning**

**Attempting to make a measurement with a test lead in an incorrect terminal might blow a fuse, damage the Meter, and cause serious personal injury.**

**Model 77 Series IV**  
Users Manual

**Battery Saver (Sleep Mode)**

The Meter enters the "Sleep" mode and blanks out the display if there is no function change or button press for 20 minutes. To disable the Sleep mode, hold down the yellow button while turning the Meter on. The Sleep mode is always disabled in the MIN MAX AVG mode and the AutoHOLD mode.

**Terminals**

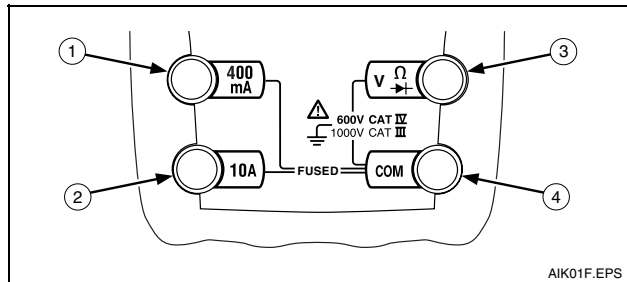

Item	Description
1	Input terminal for AC and DC milliamp measurements to 400 mA.
2	Input terminal for AC and DC current measurements to 10 A.
3	Input terminal for voltage, continuity, resistance, diode test, capacitance, and frequency measurements.
4	Common (return) terminal for all measurements.

**Rotary Switch Positions**

Switch Position	Measurement Function
$\tilde{V}$ Hz	AC voltage from 0.001 to 1000 V. Frequency from 2 Hz to 99.99 kHz.
$\bar{V}$ mV	DC voltage from 1 mV to 1000 V. DC mV from 0.1 mV to 600 mV.
$\Omega$ F	Ohms from 0.1 $\Omega$ to 50 M $\Omega$ . Farads from 1 nF to 9999 $\mu$ F.
$\text{   }$ D	Beeper turns on at <25 $\Omega$ and turns off at >250 $\Omega$ . Diode test. Displays OL above 2.4 V.
$\text{---}\tilde{\text{m}}\text{A}$ mA	AC mA from 0.01 mA to 400 mA. DC mA from 0.01 mA to 400 mA.
$\text{---}\tilde{\text{A}}$ $\tilde{\text{A}}$	AC A from 0.001 A to 10 A. DC A from 0.001 A to 10 A >10.00 display flashes. >20 A, <b>OL</b> is displayed.

Display

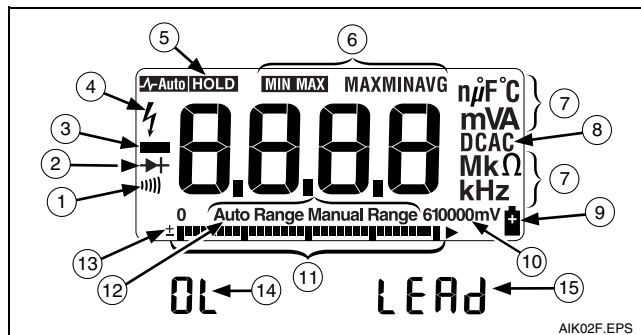

No.	Symbol	Meaning
1	)	Continuity test.
2	▶ +	Diode test.
3	—	Negative readings.
4	⚡	Unsafe voltage. Voltage $\geq 30$ V, or voltage overload (OL)
5	HOLD	AutoHOLD is enabled. Display holds present reading until it detects new stable input. Then the Meter beeps and displays new reading.
6	MIN MAX MAX , MIN, AVG	MIN MAX AVG enabled. Maximum, minimum, average, or present reading.
7	n $\mu$ F, mVA, Mk $\Omega$ , kHz	Measurement units.

No.	Symbol	Meaning
8	DC, AC	Direct current, alternating current.
9	⚡	Low battery. Replace battery.
10	610000mV	All possible ranges.
11	Bar graph	Analog display.
12	Auto Range	The Meter selects the range with the best resolution.
	Manual Range	The user selects the range.
13	±	Bar graph polarity.
14	OL	The input out of range.
15	LEAD	⚠ Test lead alert. Displayed when the rotary switch is moved to or from the mA or A position.

Error Messages	
bAtt	Replace the battery immediately.
diSC	In the capacitance function, too much electrical charge is present on the capacitor being tested.
EEPr Err	Invalid EEPROM data. Have Meter serviced.
CAL Err	Invalid calibration data. Calibrate Meter.

## Model 77 Series IV Users Manual

---

### MIN MAX AVG Recording Mode

The MIN MAX AVG recording mode captures the minimum and maximum input values, and calculates a running average of all readings. When a new high or low is detected, the Meter beeps.

#### Note

*For dc functions, accuracy is the specified accuracy of the measurement function  $\pm 12$  counts for changes longer than 275 ms in duration.*

*For ac functions, accuracy is the specified accuracy of the measurement function  $\pm 40$  counts for changes longer than 1.2 s in duration.*

To use MIN MAX AVG recording:

- ⇒ Make sure that the Meter is in the desired measurement function and range. (Autoranging is disabled in the MIN MAX AVG mode.)
- ⇒ Press **MIN MAX** to activate MIN MAX AVG mode. **MIN MAX** and **MAX** light, and the highest reading detected since entering MIN MAX AVG is displayed.
- ⇒ Press **MIN MAX** to step through the low (**MIN**), average (**AVG**), and present readings.
- ⇒ To pause MIN MAX AVG recording without erasing stored values, press **HOLD**. **HOLD** is displayed.  
To resume MIN MAX AVG recording, press **HOLD** again. **HOLD** turns off.
- ⇒ To exit and erase stored readings, press **MIN MAX** for 1 second or turn the rotary switch.

### AutoHOLD Modes

#### ⚠ ⚠ Warning

**To avoid electric shock, do not use the AutoHOLD mode to determine if a circuit is live. Unstable or noisy readings will not be captured.**

In the AutoHOLD mode, the Meter holds the reading on the display until it detects a new stable reading. Then the Meter beeps, and displays the new reading.

- ⇒ Press **HOLD** to activate AutoHOLD. **HOLD** lights.
- ⇒ Press **HOLD** again or turn the rotary switch to resume normal operation.

### YELLOW Button

Press the yellow button to select alternate measurement functions on a rotary switch setting, e.g., to select DC mA, DC A, Hz, capacitance, or diode test.

### Display Backlight

Press  to toggle the backlight on and off. The backlight automatically turns off after 2 minutes.

### Manual Ranging and Autoranging

The Meter has both Manual range and Autorange modes.

- ⇒ In the Autorange mode, the Meter selects the range with the best resolution.
- ⇒ In the Manual Range mode, you override Autorange and select the range yourself.

When you turn the Meter on, it defaults to Autorange and **Auto Range** is displayed.

1. To enter the Manual Range mode, press **RANGE**. **Manual Range** is displayed.
2. In the Manual Range mode, press **RANGE** to increment the range. After the highest range, the Meter wraps to the lowest range.

*Note*

*You cannot manually change the range in the MIN MAX AVG mode.*





*If you press **RANGE** while in MIN MAX\_AVG, the Meter beeps, indicating an invalid operation, and the range does not change.*

3. To exit Manual Range, press **RANGE** for 1 second or turn the rotary switch.  
The Meter returns to Autorange and **Auto Range** is displayed.

### Power-Up Options

To select a Power-Up Option, hold down the button indicated while turning the Meter on.

Power-Up Options are cancelled when the Meter is turned OFF.

Button	Power-Up Options
	Turns on all display segments when in VAC switch position.
	Disables beeper. bEEP is displayed when enabled.
	Enables "Smoothing" mode. S--- is displayed when enabled. Dampens display fluctuations of rapidly changing inputs by digital filtering.
 (YELLOW)	Disables automatic power-down ("Sleep mode"). Poff is displayed when enabled Sleep mode is also disabled while the Meter is in a MIN MAX AVG Recording mode, or the AutoHOLD mode.
	Disables automatic 2-minute backlight timeout. L off is displayed when enabled.



**Model 77 Series IV**  
**Users Manual**

---

**Making Basic Measurements**

The figures on the following pages show how to make basic measurements.

When connecting the test leads to the circuit or device, connect the common (**COM**) test lead before connecting the live lead; when removing the test leads, remove the live lead before removing the common test lead.

**Warning**

To avoid electric shock or injury, or damage to the Meter, disconnect circuit power and discharge all high-voltage capacitors before testing resistance, continuity, diodes, or capacitance.

**Measuring AC and DC Voltage**

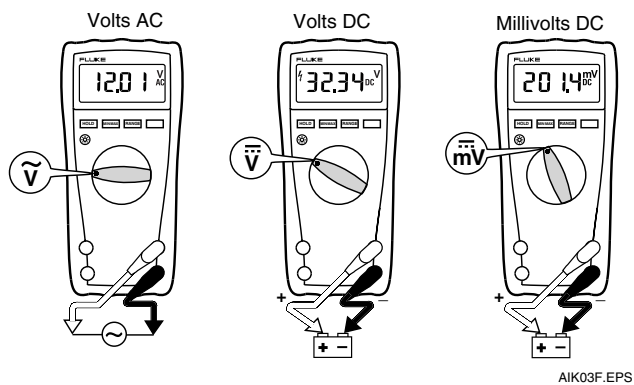

**Measuring Resistance**

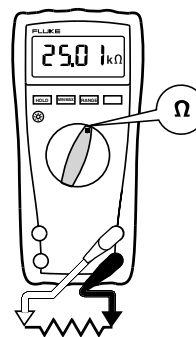

AIK04F.EPS

**Measuring Capacitance**

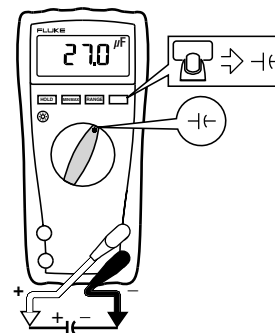

AIK05F.EPS

Testing for Continuity

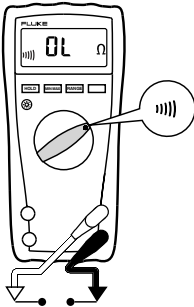
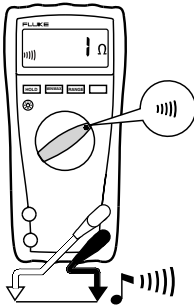

AIK06F.EPS

Testing Diodes

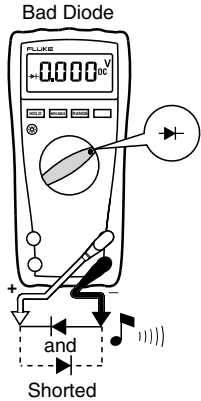
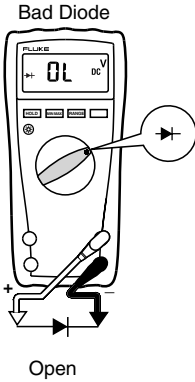
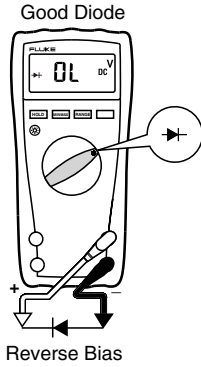
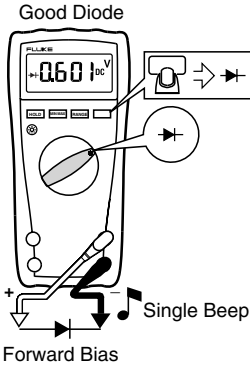

AIK07F.EPS

**Model 77 Series IV**  
Users Manual

**Measuring AC or DC Current**

**Warning**

To avoid personal injury or damage to the Meter:

- Never attempt to make an in-circuit current measurement when the open-circuit potential to earth ground is >1000 V.
- Check the Meter's fuses before testing. (See "Testing the Fuses".)
- Use the proper terminals, switch position, and range for your measurement.
- Never place the probes in parallel with a circuit or component when the leads are plugged into the current terminals.

Turn power OFF, break circuit, insert Meter in series, turn power on.

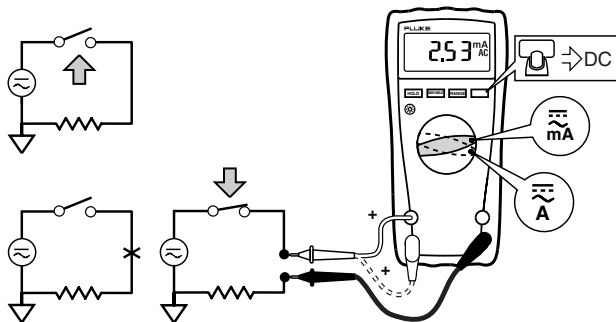

AIK08F.EPS

**Measuring Frequency**

**Warning**

To avoid electrical shock, disregard the bar graph for frequencies >1 kHz. If the frequency of the measured signal is >1 kHz, the bar graph is unspecified.

The Meter measures the frequency of a signal. The trigger level is 0 V ac for all ranges.

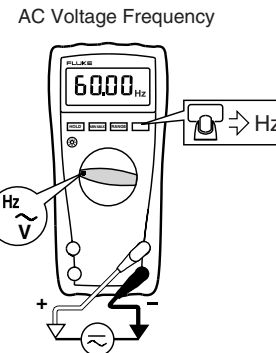

EOM09F.EPS

- ⇒ To exit frequency, press yellow button or turn the rotary switch.
- ⇒ In frequency, the bar graph shows the ac voltage accurately up to 1 kHz.
- ⇒ Select progressively lower ranges using manual ranging for a stable reading.

**Using the Bar Graph**

The bar graph is like the needle on an analog Meter. There is an overload indicator (▶) to the right, and a polarity indicator (±) to the left.

Because the bar graph is much faster than the digital display, the bar graph is useful for making peak and null adjustments, and for observing rapidly changing inputs.

The bar graph is disabled when measuring capacitance. In frequency, the bar graph accurately indicates the voltage or current up to 1 kHz.

*The number of lit segments indicates the measured value and is relative to the full-scale value of the selected range.*

For example, in the 60 V range (see below), the major divisions on the scale represent 0, 15, 30, 45, and 60 V. An input of -30 V lights the negative sign and the segments up to the middle of the scale.

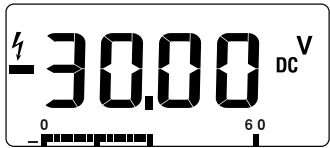

AIK11F.EPS

**Cleaning**

Wipe the case with a damp cloth and mild detergent. Do not use abrasives or solvents. Dirt or moisture in the terminals can affect readings.

**Testing the Fuses**

**Warning**

**To avoid electrical shock or injury, remove the test leads and any input signals before replacing the fuse.**

Test fuses as shown below.

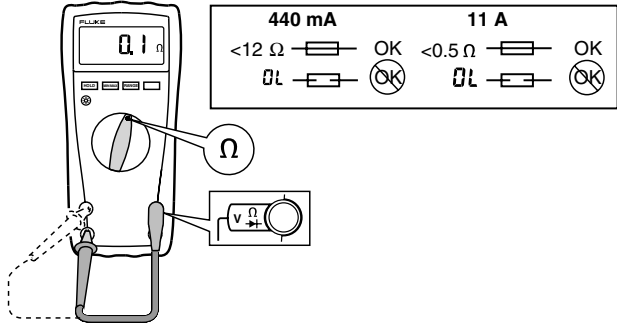

AIK12F.EPS

**Replacing the Battery and Fuses**

⚠⚠ Warning

To avoid shock, injury, or damage to the Meter:

- Use **ONLY** fuses with the amperage, interrupt, voltage, and speed ratings specified. Disconnect test leads before opening case.

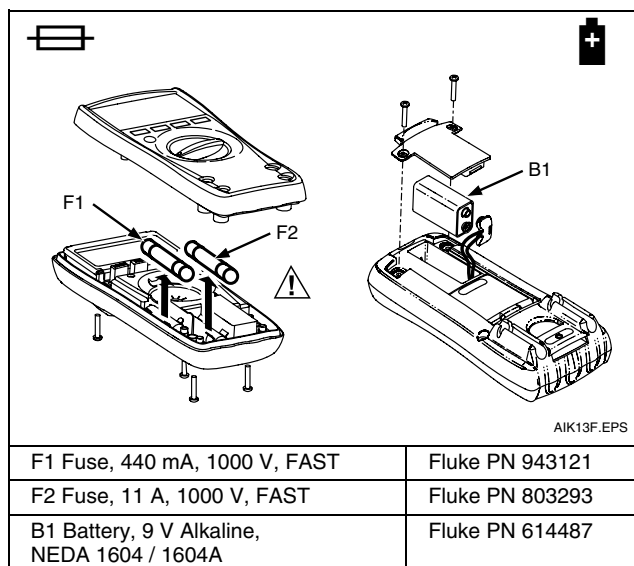

**Specifications**

Accuracy is specified for 1 year after calibration, at operating temperatures of 18 °C to 28 °C, with relative humidity at 0 % to 90 %. Accuracy specifications take the form of the following calculations:

$$\pm ( [ \% \text{ of Reading } ] + [ \text{ Counts } ] )$$

<b>Maximum voltage between any terminal and earth ground:</b>	1000
<b>Surge Protection:</b>	8 kV peak per IEC 61010
<b>⚠ Fuse for mA inputs:</b>	440 mA, 1000 V FAST Fuse
<b>⚠ Fuse for A input:</b>	11 A, 1000 V FAST Fuse
<b>Display:</b>	Digital: 6000 counts, updates 4/sec Bar Graph: 33 segments; updates 32/sec Frequency: 10,000 counts Capacitance: 1,000 counts
<b>Altitude:</b>	Operating: 2000 m; Storage: 12,000 m
<b>Temperature:</b>	Operating: -10 °C to +50 °C; Storage: -40 °C to +60 °C
<b>Temperature coefficient:</b>	0.1 X (specified accuracy) / °C (<18 °C or >28 °C)
<b>Electromagnetic Compatibility (EN 61326-1:1997):</b>	In an RF field of 3 V/M, accuracy = specified accuracy.
<b>Relative Humidity:</b>	Maximum, noncondensing 90 % to 35 °C 75 % to 40 °C; 45 % to 50 °C
<b>Battery Life:</b>	Alkaline: 400 hrs typical
<b>Size (H x W x L):</b>	4.3 cm x 9 cm x 18.5 cm
<b>Weight:</b>	420 g
<b>Safety Compliances:</b>	ANSI/ISA S82.02.01, CSA C22.2-1010.1, IEC 61010 to 1000 V Measurement Category III, 600 V Measurement Category IV
<b>Certifications:</b>	CSA, TÜV (EN61010), UL, CE, (N10140), VDE

**Model 77 Series IV**  
Users Manual

Function	Range	Resolution	Accuracy $\pm$ ( [ % of Reading ] + [ Counts ] )
AC Volts (Average responding)	6.000 V 60.00 V 600.0 V 1000 V	0.001 V 0.01 V 0.1 V 1 V	2.0 % + 2 (45 Hz to 1 kHz)
DC mV	600.0 mV	0.1 mV	0.3 % + 1
DC Volts	6.000 V 60.00 V 600.0 V 1000 V	0.001 V 0.01 V 0.1 V 1 V	0.3 % + 1
Continuity	600 $\Omega$	1 $\Omega$	Meter beeps at <25 $\Omega$ , beeper turns off at >250 $\Omega$ ; detects opens or shorts of 250 $\mu$ s or longer.
Ohms	600.0 $\Omega$ 6.000 k $\Omega$ 60.00 k $\Omega$ 600.0 k $\Omega$ 6.000 M $\Omega$ 50.00 M $\Omega$	0.1 $\Omega$ 0.001 k $\Omega$ 0.01 k $\Omega$ 0.1 k $\Omega$ 0.001 M $\Omega$ 0.01 M $\Omega$	0.5 % + 2 0.5 % + 1 0.5 % + 1 0.5 % + 1 0.5 % + 1 2.0 % + 1
Diode test	2.400 V	0.001 V	1 % + 2
Capacitance	1000 nF 10.00 $\mu$ F 100.0 $\mu$ F 9999 $\mu$ F <sup>[1]</sup>	1 nF 0.01 $\mu$ F 0.1 $\mu$ F 1 $\mu$ F	1.2 % + 2 1.2 % + 2 1.2 % + 2 10 % typical
AC Amps (Average responding) <sup>[2]</sup>	60.00 mA 400.0 mA <sup>[3]</sup> 6.000 A 10.00 A <sup>[4]</sup>	0.01 mA 0.1 mA 0.001 A 0.01 A	2.5 % + 2 (45 Hz to 1 kHz)
<p>[1] In the 9999 <math>\mu</math>F range for measurements to 1000 <math>\mu</math>F, the measurement accuracy is 1.2 % + 2.  [2] Amps input burden voltage (typical): 400 mA input 2 mV/mA, 10 A input 37 mV/A.  [3] 400.0 mA accuracy specified up to 600 mA overload.  [4] &gt;10 A unspecified.</p>			

Specifications

Function	Range	Resolution	Accuracy ± ( [ % of Reading ] + [ Counts ] )
DC Amps <sup>[3]</sup>	60.00 mA 400.0 mA <sup>[4]</sup> 6.000 A 10.00 A <sup>[5]</sup>	0.01 mA 0.1 mA 0.001 A 0.01 A	1.5 % + 2
Hz <sup>[1][2]</sup> (ac voltage input )	99.99 Hz 999.9 Hz 9.999 kHz 99.99 kHz	0.01 Hz 0.1 Hz 0.001 kHz 0.01 kHz	0.1 % + 1
MIN MAX AVG	For dc functions, accuracy is the specified accuracy of the measurement function ±12 counts for changes longer than 275 ms in duration. For ac functions, accuracy is the specified accuracy of the measurement function ±40 counts for changes longer than 1.2 s in duration.		
<p>[1] Frequency is specified from 2 Hz to 99.99 kHz.                  [2] Below 2 Hz, the display shows zero Hz.                  [3] Amps input burden voltage (typical): 400 mA input 2 mV/mA, 10 A input 37 mV/A.                  [4] 400.0 mA accuracy specified up to 600 mA overload.                  [5] &gt;10 A unspecified.</p>			



**Model 77 Series IV**  
*Users Manual*

---

Function	Overload Protection <sup>[1]</sup>	Input Impedance (Nominal)	Common Mode Rejection Ratio (1 k $\Omega$ Unbalanced)		Normal Mode Rejection
Volts AC	1000 V	>10 M $\Omega$ <100 pF	>60 dB @ dc, 50 Hz or 60 Hz		
Volts DC	1000 V	>10 M $\Omega$ <100 pF	>120 dB @ dc, 50 Hz or 60 Hz		>60 dB @ 50 Hz or 60 Hz
mV	1000 V <sup>[2]</sup>	>10 M $\Omega$ <100 pF	>120 dB @ dc, 50 Hz or 60 Hz		>60 dB @ 50 Hz or 60 Hz
		<b>Open Circuit Test Voltage</b>	<b>Full Scale Voltage To:</b> 6.0 M $\Omega$ 50 M $\Omega$		<b>Short Circuit Current</b>
Ohms/Capacitance	1000 V <sup>[2]</sup>	<8.0 V dc	<660 mV dc	<4.6 V dc	<1.1 mA
Continuity/Diode test	1000 V <sup>[2]</sup>	<8.0 V dc	2.4 V dc		<1.1 mA
<sup>[1]</sup> 10 <sup>7</sup> V-Hz maximum. <sup>[2]</sup> For circuits <0.3 A short circuit. 660 V for high energy circuits.					

Function	Overload Protection	Overload
mA	Fused, 440 mA, 1000 V FAST Fuse	600 mA overload for 2 minutes maximum, 10 minutes rest.
A	Fused, 11 A, 1000 V FAST Fuse	20 A overload for 30 seconds maximum, 10 minutes rest.