

373

Clamp Meter

Calibration Manual

LIMITED WARRANTY AND LIMITATION OF LIABILITY

Each Fluke product is warranted to be free from defects in material and workmanship under normal use and service. The warranty period is three years and begins on the date of shipment. Parts, product repairs, and services are warranted for 90 days. This warranty extends only to the original buyer or end-user customer of a Fluke authorized reseller, and does not apply to fuses, disposable batteries, or to any product which, in Fluke's opinion, has been misused, altered, neglected, contaminated, or damaged by accident or abnormal conditions of operation or handling. Fluke warrants that software will operate substantially in accordance with its functional specifications for 90 days and that it has been properly recorded on non-defective media. Fluke does not warrant that software will be error free or operate without interruption.

Fluke authorized resellers shall extend this warranty on new and unused products to end-user customers only but have no authority to extend a greater or different warranty on behalf of Fluke. Warranty support is available only if product is purchased through a Fluke authorized sales outlet or Buyer has paid the applicable international price. Fluke reserves the right to invoice Buyer for importation costs of repair/replacement parts when product purchased in one country is submitted for repair in another country.

Fluke's warranty obligation is limited, at Fluke's option, to refund of the purchase price, free of charge repair, or replacement of a defective product which is returned to a Fluke authorized service center within the warranty period.

To obtain warranty service, contact your nearest Fluke authorized service center to obtain return authorization information, then send the product to that service center, with a description of the difficulty, postage and insurance prepaid (FOB Destination). Fluke assumes no risk for damage in transit. Following warranty repair, the product will be returned to Buyer, transportation prepaid (FOB Destination). If Fluke determines that failure was caused by neglect, misuse, contamination, alteration, accident, or abnormal condition of operation or handling, including overvoltage failures caused by use outside the product's specified rating, or normal wear and tear of mechanical components, Fluke will provide an estimate of repair costs and obtain authorization before commencing the work. Following repair, the product will be returned to the Buyer transportation prepaid and the Buyer will be billed for the repair and return transportation charges (FOB Shipping Point).

THIS WARRANTY IS BUYER'S SOLE AND EXCLUSIVE REMEDY AND IS IN LIEU OF ALL OTHER WARRANTIES, EXPRESS OR IMPLIED, INCLUDING BUT NOT LIMITED TO ANY IMPLIED WARRANTY OF MERCHANTABILITY OR FITNESS FOR A PARTICULAR PURPOSE. FLUKE SHALL NOT BE LIABLE FOR ANY SPECIAL, INDIRECT, INCIDENTAL OR CONSEQUENTIAL DAMAGES OR LOSSES, INCLUDING LOSS OF DATA, ARISING FROM ANY CAUSE OR THEORY.

Since some countries or states do not allow limitation of the term of an implied warranty, or exclusion or limitation of incidental or consequential damages, the limitations and exclusions of this warranty may not apply to every buyer. If any provision of this Warranty is held invalid or unenforceable by a court or other decision-maker of competent jurisdiction, such holding will not affect the validity or enforceability of any other provision.

Table of Contents

Title	Page
Introduction.....	1
Contact Fluke.....	1
Safety Information	2
The Meter.....	5
Specifications.....	5
Mechanical Specifications.....	6
Environmental Specifications.....	6
Performance Tests.....	7
Calibration Adjustment.....	8
Required Equipment.....	8
Calibration Adjustment	8
Adjustment Procedure	9
Maintenance.....	10
Clean the Product	10
Battery Replacement	10
User Replaceable Parts	11

List of Tables

Table	Title	Page
1.	Symbols.....	4
2.	Performance Tests.....	7
3.	Required Equipment.....	8
4.	User Replaceable Parts.....	11

List of Figures

Figure	Title	Page
1.	The Meter	5
2.	Changing the Batteries	11

Introduction

Warning

Read "Safety Information" before you use the Product.

This manual explains the Calibration Adjustment for the 373 Clamp Meter (the Product). Please see the *373 Users Manual* for usage information.

Safety Information

A **Warning** identifies conditions and actions that pose hazard(s) to the user. A **Caution** identifies conditions and procedures that could cause Meter damage, equipment under test damage, or permanent loss of data.

Symbols used on the Product and in this manual are explained in Table 1.

Warning

To prevent possible electrical shock, fire, or personal injury:

- Use the product only as specified, or the protection supplied by the Product can be compromised.
- Examine the case before you use the Product. Look for cracks or missing plastic. Carefully look at the insulation around the terminals.
- Do not measure current while the test leads are in the input jacks.
- The battery door must be closed and locked before you operate the Product.
- Remove all probes, test leads, and accessories before the battery door is opened.
- Do not use test leads if they are damaged. Examine the test leads for damaged insulation, exposed metal, or if the wear indicator shows. Check test lead continuity.
- Do not use the Product if it operates incorrectly.
- Do not use the Product around explosive gas, vapor, or in damp or wet environments.
- Use only type AA batteries, properly installed in the Product case, to power the Product.
- Hold the Product behind the tactile barrier. See Figure 1, ①.
- Replace the batteries when the low battery indicator () shows to prevent incorrect measurements.
- Use only specified replacement parts.
- Have an approved technician repair the product.
- Do not touch voltages >30 V ac rms, 42 V ac peak, or 60 V dc.
- Do not apply more than the rated voltage, between the terminals or between each terminal and earth ground.
- Keep fingers behind the finger guards on the probes.
- Connect the common test lead before the live test lead and remove the live test lead before the common test lead.
- Do not work alone.

- Use caution around bare conductors or bus bars. To prevent electrical shock, do not touch the conductor.
- Comply with local and national safety codes. Use personal protective equipment (approved rubber gloves, face protection, and flame-resistant clothes) to prevent shock and arc blast injury where hazardous live conductors are exposed.
- Disconnect power and discharge all high-voltage capacitors before you measure resistance or continuity.
- Do not measure ac/dc current in circuits carrying more than 600 V or 200 A with the Product Jaw.
- Do not operate the product with covers removed or the case open. Hazardous voltage exposure is possible.
- When white wear indicator insulation shows through the clamp cable jacket, replace the clamp cable.
- Do not exceed the Measurement Category (CAT) rating of the lowest rated individual component of a product, probe, or accessory.
- Measure a known voltage first to make sure that the Product operates correctly.

⚠ Caution

To prevent possible damage to the product or to equipment under test:

- Use the correct terminals, function, and range for measurements.
- Clean the case and accessories with a damp cloth and mild detergent only. Do not use abrasives or solvents.

Table 1. Symbols

Symbol	Meaning	Symbol	Meaning
	AC (Alternating Current)		Earth ground
	DC (Direct Current)		Do not dispose of this product as unsorted municipal waste. Go to Fluke's website for recycling information.
	Hazardous voltage		Conforms to European Union directives.
	Risk of Danger. Important information. See Manual.		Conforms to relevant North American Safety Standards.
	Battery		Double insulated
	Examined and licensed by TÜV Product Services.		Conforms to relevant Australian standards.
CAT III	IEC Measurement Category III CAT III equipment has protection against transients in equipment in fixed-equipment installations, such as distribution panels, feeders and short branch circuits, and lighting systems in large buildings.	CAT IV	IEC Measurement Category IV CAT IV equipment has protection against transients from the primary supply level, such as an electricity Meter or an overhead or underground utility service.
	Application around and removal from HAZARDOUS LIVE conductors is permitted.		

Note

The Measurement Category (CAT) and voltage rating of any combination of test probe, test probe accessory, current clamp accessory, and the Meter is the LOWEST rating of any individual component.

The Meter

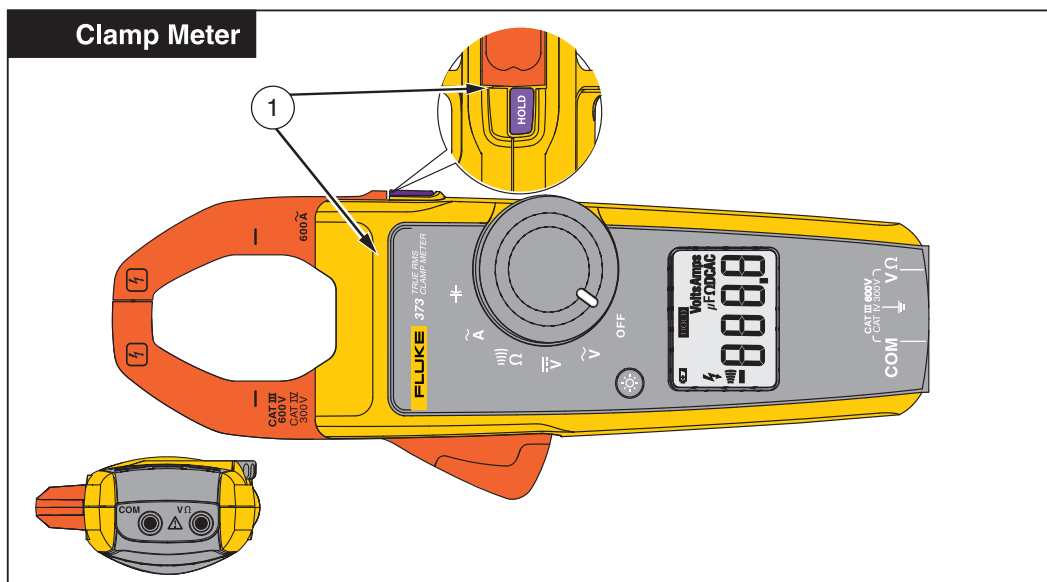

Figure 1. The Meter

gh1008.eps

Specifications

AC Current

Range	600.0 A
Resolution	0.1 A
Accuracy	2 % ± 5 digits (48 – 62 Hz)
Crest Factor (50/60 Hz)	2.5 @ 600 A

AC Voltage

Range	600.0 V
Resolution	0.1 V
Accuracy	1.0 % ± 5 digits (48 – 62 Hz)

DC Voltage

Range	600.0 V
Resolution	0.1 V
Accuracy ^[1]	1 % ± 5 digits

^[1] in an RF field greater than 1 V/m between 130 MHz and 350 MHz, add 65 counts to specified accuracy.

Resistance

Range	600.0 Ω/6000 Ω
Resolution	0.1 Ω/1 Ω
Accuracy	1 % ± 5 digits
Continuity Beeper	≤ 30 Ω

Capacitance

Range	10.0 – 100.0 μF / 1000 μF
Resolution	0.1 μF/1 μF
Accuracy	1.9 % ± 2 digits

Mechanical Specifications

Size (L x W x H) 232 mm x 85 mm x 45 mm

Weight..... 370 g

Environmental Specifications

Operating Temperature..... -10 °C to +50 °C

Storage Temp -40 °C to +60 °C

Operating Humidity Non condensing (< 10 °C)
 ≤ 90 % RH (at 10 °C to 30 °C)
 ≤ 75 % RH (at 30 °C to 40 °C)
 ≤ 45 % RH (at 40 °C to 50 °C)
 (Without Condensation)

Operating Altitude 3000 meters



Storage Altitude 12,000 meters

EMI, EMC..... Meets all applicable requirements in EN61326-1:2006

Temperature Coefficients..... Add 0.1 x specified accuracy for each degree C above
 28 °C or below 18 °C

Safety Compliance..... ANSI/ISA S82.02.01:2004
 CAN/CSA-C22.2 No. 61010-1-04
 IEC/EN 61010-1:2001, 600V CAT III, 300V CAT IV
 Pollution Degree 2
 EN/IEC 61010-2-32:2002
 CAN/CSA-C22.2 No. 61010-2-032 :04



Agency Approvals   

Batteries..... 2 AA, NEDA 15A, IEC LR6







Performance Tests

⚠ ⚠ Warning

To prevent possible electrical shock, fire, or personal injury, do not perform the performance test procedures unless the Product is fully assembled.

The following performance tests verify the complete operation of the Product and check the accuracy of each function against the Product's specifications. See Table 2. If the Product fails any part of the test, calibration adjustment and/or repair is indicated. See "Calibration Adjustment".

Table 2. Performance Tests

Test (Switch Position)	Calibrator Output	UUT Meter Reading Limit	
		Low	High
 AC Volts	20.0 V @ 50 Hz	19.3	20.7
	600.0 V @ 50 Hz	593.5	606.5
 DC Volts	+20.0 V	19.3	20.7
	-20.0 V	-20.7	-19.3
	+600.0 V	593.5	606.5
	-600.0 V	-606.5	-593.5
 Amps AC (w/50 turn coil)	0.4 A @ 50 Hz	19.1	20.9
	4 A @ 50 Hz	195.5	204.5
	10 A @ 50 Hz	489.5	510.5
	12 A @ 50 Hz	587.5	612.5
 Ohms	600.0 Ω	593.5	606.5
	6000 Ω	5940	6060
 Capacitance	100.0 μF	97.9	102.1
	1000 μF	981	1019
 Continuity	25 Ω	Beeper on	

Calibration Adjustment

Required Equipment

The equipment listed in Table 3 is required for calibration adjustment.

Table 3. Required Equipment

Equipment	Required Characteristics	Recommended Model
Calibrator	4.5 digit resolution	Fluke 5520A Calibrator or equivalent
Wired coil	50 turns	Fluke 5500A/COIL

Calibration Adjustment





Each Product function can be calibrated separately or in any sequence. To adjust Product calibration:

1. Turn the Product over to access the battery compartment door screw.
2. Use a flat-head screwdriver to loosen the battery compartment door screw and lift off the battery compartment door. See Figure 2.
3. Remove the batteries.
4. Remove the calibration sticker.
5. Place a jumper (short) across the calibration pins located under the calibration sticker. Once the Product is turned on, this will put the Product into calibration mode.
6. Reinstall the batteries.
7. Turn the Product ON.
8. Turn the rotary switch to select the function to be calibrated.
9. Apply the required output from the source to the Product. See “Adjustment Procedure” below. The calibration adjustment is complete.

When the adjustment is complete:

1. Remove the batteries.
2. Remove the jumper.
3. Replace calibration sticker.
4. Reinstall batteries.
5. Reattach the battery compartment door.
6. Tighten the battery compartment door screw.

Adjustment Procedure

Test (Switch Position)	Product LCD Reading	Action
 AC Volts	CAL1 then 0.0 V ac	Calibrator output 0 V @ 50 HZ. Push (HOLD) to measure. Allow the reading to stabilize. Push (HOLD) again to store the value.
	200.0 V ac	Calibrator output 200.0 V @ 50 HZ. Push (HOLD) to measure. Allow the reading to stabilize. Push (HOLD) again to store the value.
 DC Volts	CAL1 then 200.0 V dc	Calibrator output 200.0 V dc. Push (HOLD) to measure. Allow the reading to stabilize. Push (HOLD) again to store the value.
 Ω Ohms	CAL1 then 300.0 Ω	Calibrator output 300 Ω. Push (HOLD) to measure. Allow the reading to stabilize. Push (HOLD) again to store the value.
	3000 Ω	Calibrator output 3000 Ω. Push (HOLD) to measure. Allow the reading to stabilize. Push (HOLD) again to store the value.
 AC Amps (with 50-turn coil)	CAL1 then 0.0 A ac	Calibrator output 0.0 A @ 50 HZ. Push (HOLD) to measure. Allow the reading to stabilize. Push (HOLD) again to store the value.
	200.0 A ac	Calibrator output 4 A @ 50 HZ. Push (HOLD) to measure. Allow the reading to stabilize. Push (HOLD) again to store the value.
 Capacitance	CAL1 then 40.0 μF	Calibrator output 40.0 μF. Push (HOLD) to measure. Allow the reading to stabilize. Push (HOLD) again to store the value.
	400.0 μF	Calibrator output 400.0 μF. Push (HOLD) to measure. Allow the reading to stabilize. Push (HOLD) again to store the value.

Maintenance

Clean the Product

⚠ Caution

To prevent possible damage to the Product or to equipment under test, do not use abrasive cleaners. They will damage the case.

To clean the Product, use a cloth with a mild cleaning solution.

Battery Replacement

⚠⚠ Warning

To prevent possible explosion, fire, or personal injury, replace the batteries when the low battery indicator (🔋) shows to prevent incorrect measurements.

⚠ Caution

To prevent possible damage to the Product or to equipment under test:

- Remove batteries to prevent battery leakage and damage to the Product if it is not used for an extended period.
- Be sure that the battery polarity is correct to prevent battery leakage.

To change the batteries, see Figure 2:

1. Make sure the Product is OFF.
2. Turn the Product over to access the battery compartment door screw.
3. Use a flat-head screwdriver to loosen the battery compartment door screw and lift off the battery compartment door.
4. Replace the two AA batteries.
5. Reattach the battery compartment door.
6. Tighten the battery compartment door screw.

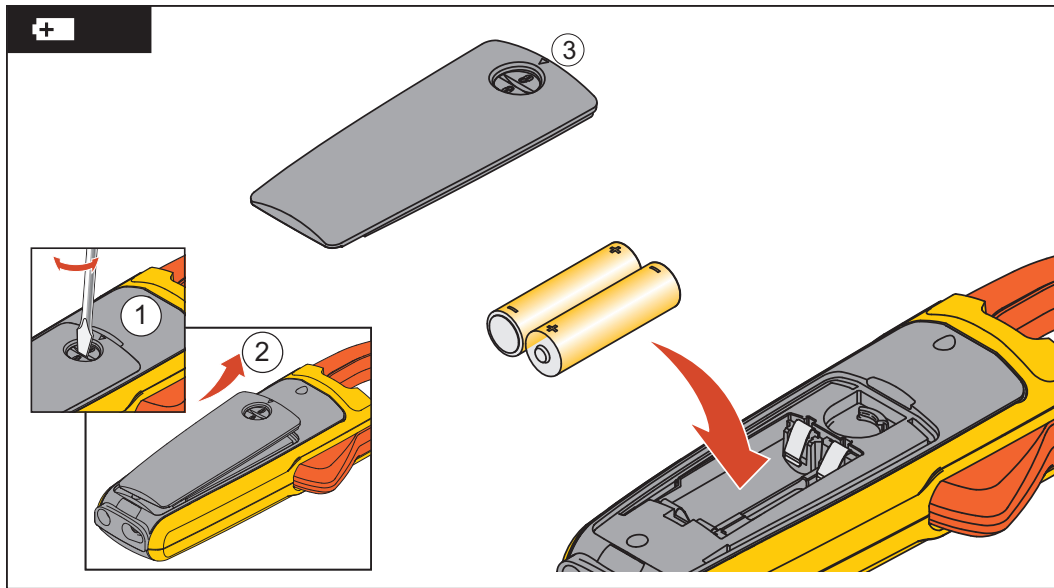

Figure 2. Changing the Batteries

ghi007.eps

User Replaceable Parts

User replaceable parts are listed in Table 4.

Table 4. User Replaceable Parts

Fluke Part Number	Description	Qty
376756	Battery (AA 1.5 V)	2
3845988	Battery Door Assembly	1
3612805	Users Manual	1
855742	TL75 Test Leads	1 Set
3752895	Soft Case	1
3868305	Calibration Sticker	1

