

323/324/325 Clamp Meters Quick Reference Guide

⚠ Warning

To prevent possible electrical shock, fire, or personal injury, read the "323/324/325 Safety Sheet" before you use this Product.

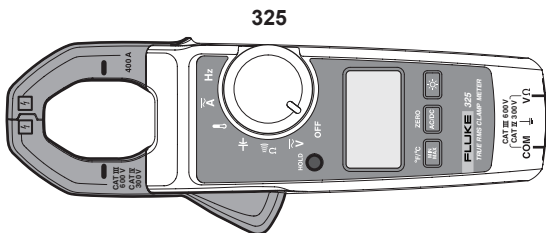

325

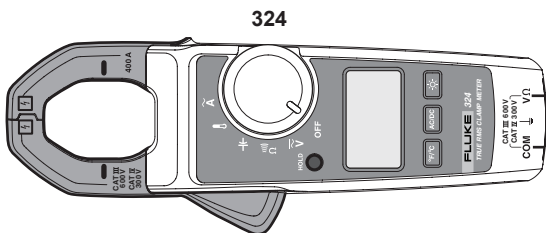

324

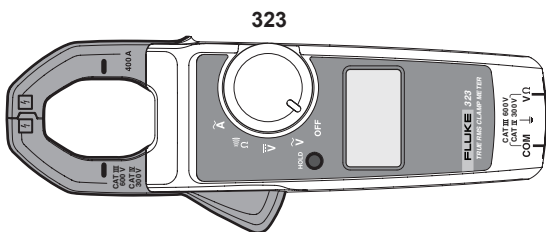

323

OFF

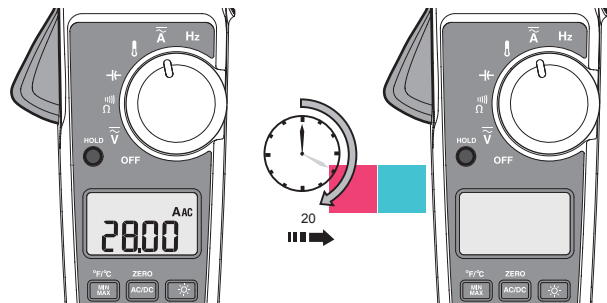

323

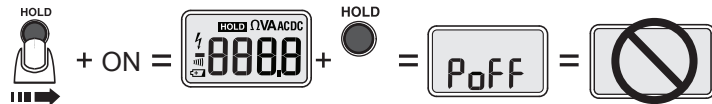

324/325

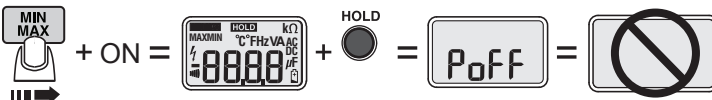

☀

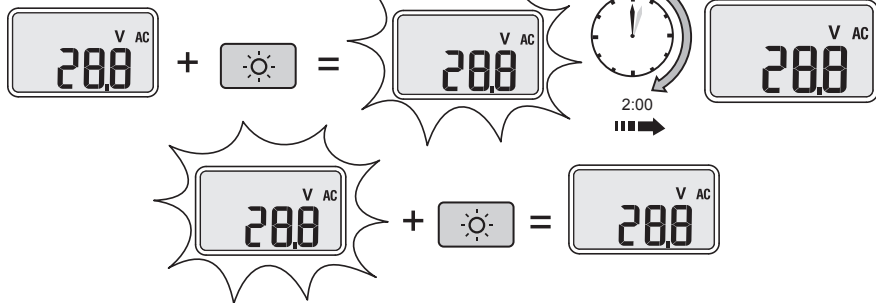

OFF

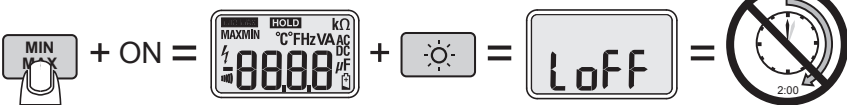

A

~A 323, 324
A 325

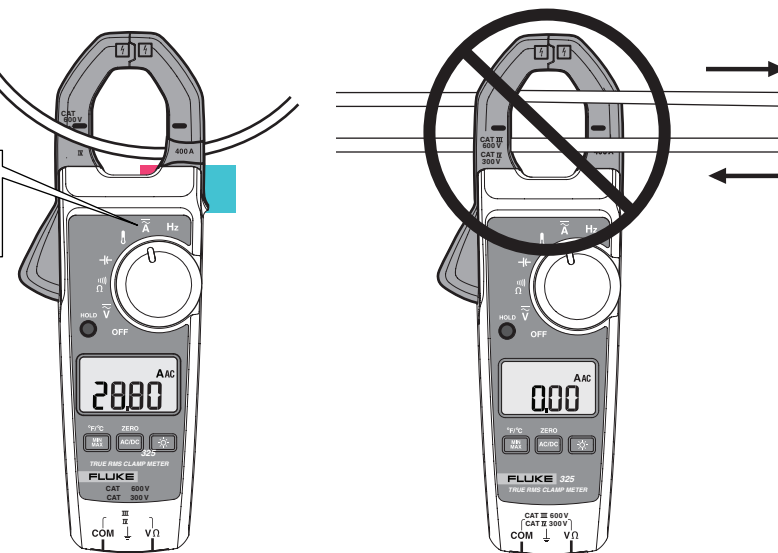

~V ~V Ω

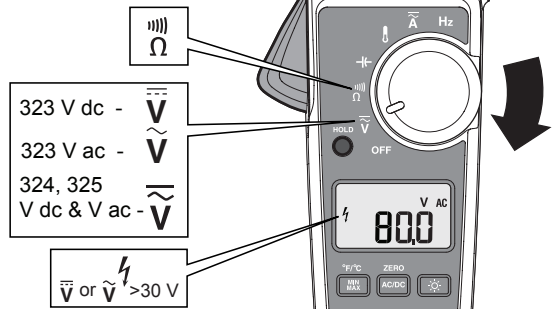

Ω

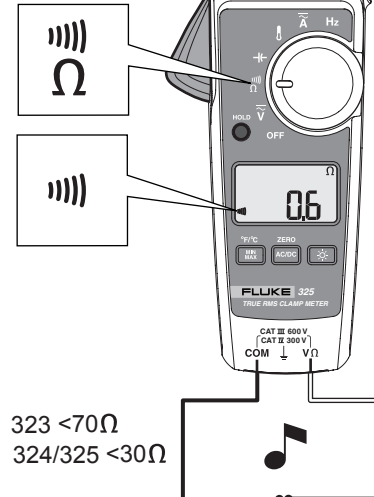

323 <70Ω
324/325 <30Ω

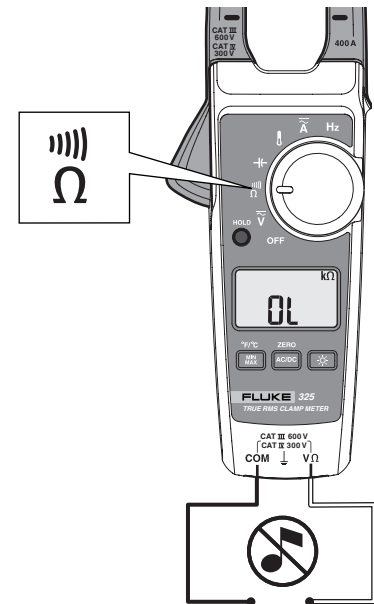

HOLD

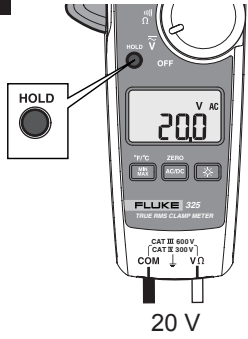

20 V

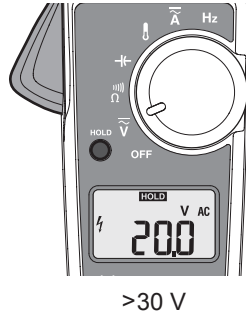

>30 V

324, 325

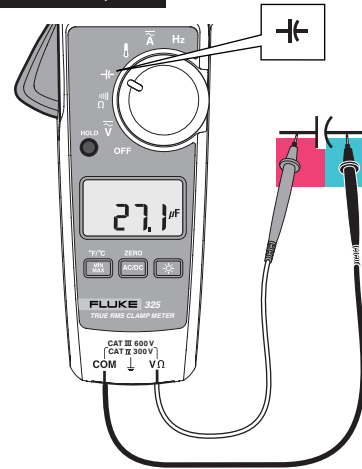

Hz 325

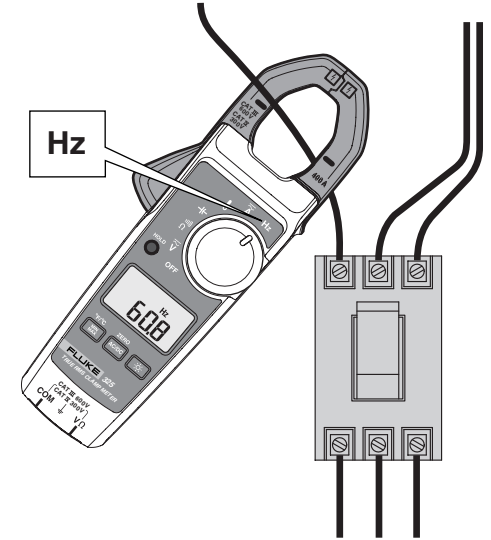

AC/DC & ZERO

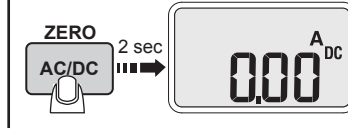
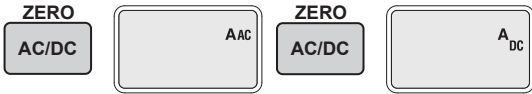

324, 325

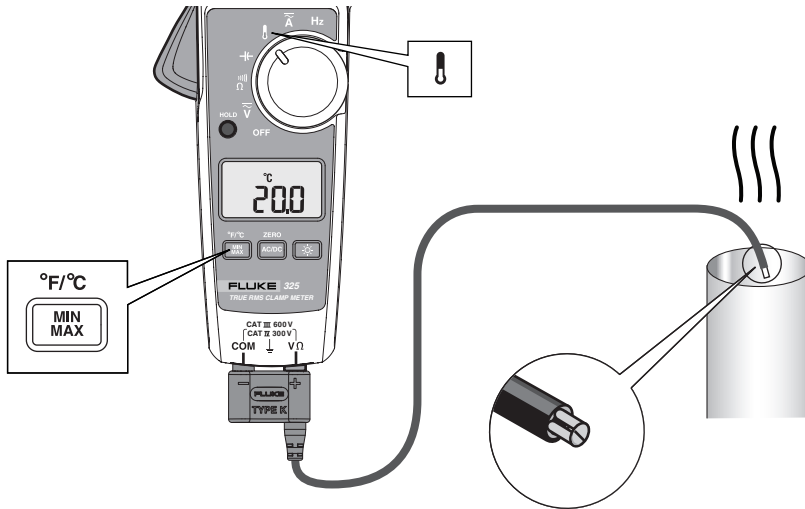

+

